

Visit ProMariner online at www.promariner.com, for a complete selection of quality marine products...

Here are just a few:

- ProMite Series - Recreational Grade Waterproof Marine Battery Chargers
- ProSport Series - Heavy Duty Recreational Grade Waterproof Marine Battery Chargers
- ProTournament Series - Professional Grade Tournament Waterproof Marine Battery Chargers
- ProSoloCharge Series - Digitally Controlled Zero Loss Charging Isolators
- Digital Mobile Charge In-Transit Chargers
- Battery Maintainers
- AC Plug Holders
- Battery Isolators
- Isolation Transformers
- Galvanic Isolators and Monitored Systems
- Corrosion Control Products
- Waterproof Marine Binoculars
- Gold Plated Fuses and Holders
- A Complete Line of Hand Held Test Meters
- Online Technical Support and Service Support

Visit frequently, we are always adding new products for your boating enjoyment!

Professional Mariner, LLC
 200 International Drive, STE 195
 Portsmouth, New Hampshire 03801
 TEL: 603-433-4440
 FAX: 603-433-4442
www.promariner.com

specifications subject to change without notice

12/11 A

ProMariner™



Global AC Input
 100-260 VAC 50/60 Hz
Power Factor Corrected



ProNauticP Series Instruction Manual

Models	Part No.	Amperage	Banks	Volts
ProNautic1210P	63110	10 Amps	2 Banks	12
ProNautic1215P	63115	15 Amps	3 Banks	12
ProNautic1220P	63120	20 Amps	3 Banks	12
ProNautic1230P	63130	30 Amps	3 Banks	12
ProNautic1240P	63140	40 Amps	3 Banks	12
ProNautic1250P	63150	50 Amps	3 Banks	12
ProNautic1260P	63160	60 Amps	3 Banks	12
ProNautic2420P	63170	20 Amps	3 Banks	24
ProNautic2430P	63180	30 Amps	3 Banks	24

IMPORTANT NOTICE

This manual contains important safety and operating instructions for the ProNauticP Series Chargers. Please save and read all safety, operating and installation instructions before installing or applying AC power to your ProNauticP Charger.

Your Satisfaction is Important to Us!

Do not return this product to retailer or dealer for any service or warranty requirements. Please call our Customer Care Department at 800-824-0524 from 8:30 am to 5pm Eastern Time for any warranty, service or installation assistance. Thank you - ProMariner Customer Care

PLEASE RECORD YOUR:

Model Number: _____ Serial Number: _____ Date of Purchase: _____

Table of Contents

Introduction...	1-3
CAUTIONS, WARNINGS AND SAFETY INSTRUCTIONS...	4-8
Installation...	9-14
Setup and Operation...	14-17
Programming...	18-20
Troubleshooting...	20
Maintenance...	21
Dimensions...	22-24
Typical Wiring Configuration...	25-27
Warranty Information...	28

Unpacking And Inspection:

Thoroughly inspect your ProNauticP unit. The package should contain the following:

- 1) ProNauticP Charger
- 2) Parts package including:
 - a. Owners/Installation manual
 - b. Warranty Card
 - c. Temperature Probe

DAMAGE – If any parts are missing or damaged, or the unit has been damaged in shipping contact ProMariner Customer Service at 1-800-824-0524, please do not take it back to place of purchase.

DO NOT attempt to install or operate the unit if it has been damaged in any way.

Introduction

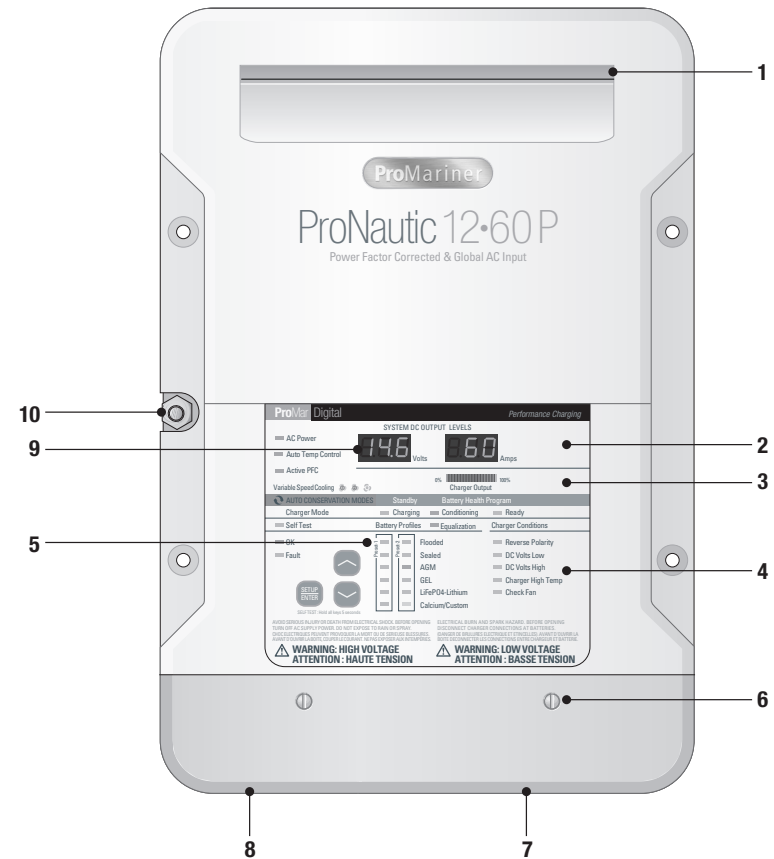

1. Cooling Vent
2. Amperage Out Display
3. Percentage of Outputs Used
4. Faults
5. Charging Profile Selected
6. AC and DC Connection Cover
7. DC Side Terminations
8. AC Side Terminations
9. Voltage Out Display
10. ABYC Recommended Bonding Stud

12 Volt Models

10 Amps	PP1210 – 2 Output
15 Amps	PP1215 – 3 Outputs
20 Amps	PP1220 – 3 Outputs
30 Amps	PP1230 – 3 Outputs
40 Amps	PP1240 – 3 Outputs
50 Amps	PP1250 – 3 Outputs
60 Amps	PP1260 – 3 Outputs

24 Volt Models

20 Amps	PP2420 – 3 Outputs
30 Amps	PP2430 – 3 Outputs

Introduction

Thank you from all of us at Professional Mariner, LLC and congratulations on the recent purchase of your ProNauticP Series On-Board Marine Battery Charger. The ProNauticP On-Board Marine Battery Charger is the latest in advanced microprocessor controlled battery charging technology and is ideal for: cuddy, cruiser, sail, house boats, yachts commercial offshore and sport fishing boats.

The ProNauticP Series is designed to be installed in an area where the charger will NOT be subjected to water. Recommended installation is in an engine room or dry compartments where 6 inches of clearance on all sides is available.

The ProNauticP Series On-Board Marine Battery Charger incorporates industry leading technology, delivering fully automatic and sequential multi-stage charging that provides electronically controlled charging, conditioning and maintenance of all batteries and or banks connected.

High Line Features:

Power Factor Correction - This ensures efficient operation of the unit regardless of the quality of the power input.

Automatic Global AC Input - This unit has been designed for 100-240VAC operation at 60Hz (US) and 50Hz. (European & Australia)

Digital Information Center - Displays real-time state of charge, charge mode and voltage/amperage in an easy to read format.

Multiple Battery Type Charging Capability - User selected battery types including new technologies such as Lithium (LiFePO4) as well as a custom setting to manually select the desired voltages.

Selectable Power Level - Adjust amperage draw of the unit to prevent it from competing with other appliances when only a lower amperage shore / station power hookup is available.

Conservation Energy Saver Mode - For better long term storage while consuming less energy.

Standard Features:

Fully Automatic – Charge rates and battery maintenance automatically controlled based on battery chemistry selected. Automatically selects between charge, conditioning and ready.

Stylish and compact on-board marine charger:

- Expanded LED operation status center with fault indicators
- Easy to navigate 3 button command center
- Electronic variable speed cooling
- No drip shield required venting design
- DC cable organizer
- AC cable organizer
- ABYC recommended bonding system connection

Warning

DO NOT attempt to install or operate the unit if it has been damaged in any way.

IMPORTANT NOTICE – PLEASE READ AND UNDERSTAND THIS MANUAL BEFORE INSTALLING YOUR PRONAUTIC P SERIES CHARGER.

This manual is written to assist in the installation of your new ProNauticP Series Charger; however, since this is a permanent AC and DC hardwired installation, ProMariner strongly recommends that a Certified Marine Electrical Technician® trained by the American Boat and Yacht Council (ABYC) perform the installation. The ProNauticP Series unit you have purchased was constructed to the safety standards of the ABYC to prevent fire and electrocution; the installation must conform to these same industry standards. For more information on ABYC, their Standards and Technical Information reports for Small Craft and to find a certified technician near you, visit www.abyc.com.

⚠ CAUTION: To preclude a safety hazard, all existing AC and DC electrical components (e.g. wire, fuses, circuit breakers, battery switches, and connections) must be inspected for proper condition prior to installation. Failure to confirm adequate condition and proper installation to ABYC standard E-11 AC & DC electrical systems on board boats may result in a dangerous condition and/or premature failure of this or other installed electrical components. Any and all areas of the existing system that are found not in compliance with ABYC E-11 must be replaced prior to installation.

⚠ CAUTION: If you are replacing an existing battery charger please disconnect the battery charger output cables from the existing charger AND the battery(s). Do not use existing cables if they are not in compliance with the sizes detailed in this manual. If you have any doubt about your ability to fuse and wire this unit correctly PLEASE refer to www.abyc.com for a list of certified electricians in your area that are qualified to perform this installation to the ABYC standards.

Important Notice: FCC Class B Notification & International Standards Compliance

NOTE: This equipment has been tested and found to comply with the limits for a class B digital device, pursuant to Part 15 of the FCC Rules. These limits are designed to provide reasonable protection against harmful interference when the equipment is operated in a commercial environment. This equipment generates, uses, and can radiate radio frequency energy and, if not installed and used in accordance with the instruction manual, may cause harmful interference to radio communications.

Designed, Constructed and Tested to:
 UL 1236 SB, CSA C22.2-107.2, FCC Class B
 EN60335-1/2-29, EN60335-2-29, EN61000-3-2, EN61000-3-3
 Complies w/ ABYC A-31, AC Input Power Factor Corrected, Meets EN61000-302:2000 + A2:2005

Safety Certified by:



Warning

⚠ WARNING: HIGH VOLTAGE / ATTENTION : HAUTE TENSION

AVOID SERIOUS INJURY OR DEATH FROM ELECTRICAL SHOCK. BEFORE OPENING TURN OFF AC SUPPLY POWER. CHOC ELECTRIQUES PEUVENT PROVOQUER LA MORT OU DE SERIEUSE BLESSURES. AVANT D'OUVRIR LA BOITE, COUPER LE COURANT.

⚠ WARNING: LOW VOLTAGE / ATTENTION : BASSE TENSION

ELECTRICAL BURN AND SPARK HAZARD. BEFORE OPENING DISCONNECT CHARGER CONNECTIONS AT BATTERY(S). (DANGER DE BRULURES ELECTRIQUE ET ETINCELLES). AVANT D'OUVRIR LA BOITE DECONNECTER LES CONNECTIONS ENTRE CHARGEUR ET BATTERIE.

⚠ WARNING / AVERTISSEMENT :

DO NOT EXPOSE TO RAIN OR SPRAY / NE PAS EXPOSER AUX INTEMPERIES

⚠ CAUTION:

- HOT SURFACES - TO REDUCE THE RISK OF BURNS, DO NOT TOUCH.
- CHARGE ONLY USER SELECTABLE TYPE BATTERIES (FLOODED, AGM, GEL OR CALCIUM) OTHER TYPES OF BATTERIES MAY BURST CAUSING PERSONAL INJURY AND DAMAGE
- RISK OF ELECTRIC SHOCK. NO USER SERVICEABLE PARTS. RETURN TO MANUFACTURER FOR SERVICING
- THIS CHARGER IS MEANT FOR CONTINUOUS DUTY
- IGNITION PROTECTED
- FOR MARINE USE

⚠ ATTENTION :

- SURFACES CHAUDE-NE PAS TOUCHER, RISQUES DE BRULURES
- UTILISER POUR ATTENTION: CHARGER UNIQUEMENT LES BATTERIES DU TYPE (PLOMB/ACIDE OU PLOMB/GEL/AGM ET BATTERIE AU CALCIUM). D'AUTRES TYPES DE BATTERIES POURRAIENT ECLATER ET CAUSER DES BLESSURES OU DOMMAGES
- RISQUE DE CHOCS ELECTRIQUE-RETOURNER AU FABRIQUANT POUR SERVICE.
- CE CHARGEUR EST FABRIQUE POUR LE DEVOIR CONTINU
- PROTÉGÉ CONTRE L'EXPLOSION
- POUR UTILIZATION MARINE

Before connecting to batteries or AC power, read all instructions and cautionary markings on the battery charger and batteries. Do not discard this manual, save it for future reference.

1. SAVE THESE INSTRUCTIONS - This manual contains important safety, operating and installation instructions for the ProNauticP Series Battery Charger. **Do not discard this manual, save it for future reference.**

2. Do not expose charger to rain or snow.
3. Use of attachments not recommended or sold by Professional Mariner, LLC will void warranty and may result in a risk of fire, electrical shock or personal injury.
4. Do not operate the charger if it has received a sharp blow, direct hit of force, been dropped or otherwise damaged in any way.
5. Do not disassemble the battery charger. If service or repair is required please contact customer service at 1-800-824-0524. Incorrect reassembly may result in a risk of electric shock or fire.
6. To reduce the risk of electrical shock, remove 120 volt or 240 volt AC shore power. Also remove DC battery connections prior to any maintenance or cleaning. Turning off controls will not reduce this risk.

⚠ WARNING AVOID SERIOUS INJURY OR DEATH FROM FIRE, EXPLOSION OR ELECTRICAL SHOCK

- Make connection in an open atmosphere free of explosive fumes.
- Make connection in a secure manner that will avoid contact with water.

Important Safety Instructions

⚠ 7. WARNING – RISK OF EXPLOSIVE GASES.

a) WORKING IN THE VICINITY OF A LEAD-ACID BATTERY IS DANGEROUS. BATTERIES GENERATE EXPLOSIVE GASES DURING NORMAL BATTERY OPERATION. FOR THIS REASON, IT IS OF UTMOST IMPORTANCE THAT EACH TIME BEFORE USING YOUR CHARGER, YOU READ THIS MANUAL AND FOLLOW THE INSTRUCTIONS EXACTLY.

b) To reduce risk of battery explosion, follow these instructions and those published by battery manufacturer and manufacturer of any equipment you intend to use in vicinity of a battery(s). Review cautionary markings on these products.

8. PERSONAL PRECAUTIONS

- a) Someone should be within the range of your voice or close enough to come to your aid when working near a Lead-acid battery.
- b) Have plenty of soap and water nearby in case battery acid comes in contact with skin, clothes or eyes.
- c) Wear complete eye protection and clothing protection. Avoid touching eyes while working near battery(s).
- d) If battery acid contacts skin or clothing, wash immediately with soap and water. If acid enters eye, immediately flood eye with running cold water for at least 10 minutes and get medical attention immediately.
- e) NEVER smoke or allow a spark or flame in the vicinity of a battery or engine.

⚠ CAUTION - To reduce the risk of injury, charge only the battery types shown on the ProNauticP user interface label ie Lead-acid type rechargeable batteries (Flooded, Sealed Flooded, GEL (Gelled Electrolyte Lead-acid) or AGM (Absorbed Glass Mat)). Other types of batteries may burst, causing personal injury. The ProNauticP is factory set for Sealed Flooded (Lead-acid) batteries.

Incorrect assembly may result in electrical shock or fire.

f) Be extra cautious to reduce risk of dropping a metal tool onto a battery, it might spark or short-circuit the battery or other electrical hardware that may cause a fire or explosion.

g) Remove all personal metal items such as rings, bracelets, necklaces, watches, and jewelry when working near a battery. A battery can produce a short circuit current high enough to weld a ring or any other metal, causing serious burns.

h) Do not use the battery charger to charge dry cell batteries that are commonly used with home appliances i.e. a cordless power drill battery. These batteries may burst and cause injury to persons and damage to property.

i) NEVER charge a frozen battery.

9. PERSONAL SAFETY WHILE PREPARING TO CHARGE BATTERIES ON-BOARD OR OFF-BOARD

a) If necessary to remove a battery(s) from a boat to charge, always remove the negative (-) grounded terminal from battery first. Make sure all accessories in the boat are off, so as not to cause an arc.

Important Safety Instructions

- b) Be sure the area around the charger and batteries is well ventilated while the batteries are being charged. Gases can be forcefully blown away using a piece of cardboard or other nonmetallic material as a fan.
- c) When cleaning battery terminals wear full eye protection to prevent corrosive material from coming in contact with eyes.
- d) Add distilled water (**not tap or bottled water that contain minerals**) in each cell until electrolyte reaches the levels specified by the battery manufacturer. Do not overfill. For batteries without fill caps, carefully follow manufacturer's recharging instructions.
- e) Study all battery manufacturer's specific precautions such as removing cell caps while charging and recommended rates of charge.
- f) Determine battery type / charge profile for battery(s) by referring to the boat owner's manual / electrical equipment(s) package and or the manufacturer's specifications located on each battery. Make sure Battery Type and Charge Profile are properly selected before charging your batteries.

NOTE: The ProNauticP Series models are required to be mounted in the vertical position.

NOTE: This is a dry compartment unit intended not to come in contact with water. When mounting the charger please ensure water intrusion is not possible as it is not covered under warranty. DO NOT install in an open cockpit or deck where water is a factor.

NOTE: ProMariner highly recommends that this unit be installed by an ABYC Certified Electrical Technician. Guidance from ABYC E-11 AC & DC electrical systems on board boats and ABYC A-31 battery chargers and inverters is offered throughout this manual to ensure a safe, trouble free installation. Please re-read the PERSONAL PRECAUTIONS section of this manual prior to installation

⚠ This unit has been designed for PERMANENT INSTALLATION ONLY Install this unit according to these instructions. Powering this unit through a plug-and-socket configuration will void your warranty and may create a serious electric shock hazard.

LOCATION - This unit must be located in a dry, well-ventilated area, free from unsecured hardware. Do not mount the unit directly above or below batteries to prevent corrosive electrolyte or gasses from damaging the unit.

LOCATION - MOUNTING - This unit must be mounted securely to an appropriate surface (e.g. plywood bulkhead, cored fiberglass hull structure) and through-bolted if possible.

LOCATION - In addition, the following should be considered when choosing a location:

- 1) Placement of the optional remote panel—ensure the cable is long enough to reach the desired location (generally in proximity to the main panel board) and is not routed near exhaust or in an area where it can be damaged.
- 2) Service - Remember, there are items on this unit that should be routinely checked (connections, LED Status Center) ensure that there is ample room to address these issues. Also consider space to adequately swing a standard wrench. Contact between a live component and a metallic fuel line can be extremely dangerous. A minimum of 6 inches of clearance on each side must be maintained.
- 3) Cable Routing - The size of the DC cabling used is dependent upon the proximity to the battery(s) being charged. When deciding on a location, this should be a consideration. Consult the DC cable size table further on in this manual when planning your installation.

Electrical Connections

- 4) Battery Location - This unit can not be mounted directly above or below a battery due to the corrosive nature of the gasses and electrolyte. Take care to ensure that spillage of electrolyte can be contained in a proper battery box or tray in the event of a leak and that the corrosive gas given off during the use and charge cycles cannot come into contact with the unit.
- 5) Temperature - note installation is permitted in an environment of 45° C (113° F) maximum. Otherwise, it may result in output reduction to protect internal components and the performance of the unit. Check intended installation spaces before installing to prevent unit thermal shutdown. Please note ProMariner recommends at least 6" of clearance space around all sides and the front of the charger for proper cooling.

⚠ CAUTION To preclude a safety hazard, all existing AC and DC electrical components (e.g. wire, fuses, circuit breakers, battery switches, and connections) must be inspected for proper condition prior to installation. Failure to confirm adequate condition and proper installation to ABYC standard E-11 AC & DC electrical systems on-board boats may result in a dangerous condition and/or premature failure of this or other installed electrical components. Any and all areas of the existing system that are found not in compliance with ABYC E-11 must be replaced prior to installation. See www.abyc.com for a limited use copy of E-11 and the other applicable standards.

⚠ CAUTION If you are replacing an existing battery charger please disconnect the battery charger output cables from the existing charger AND the battery(s). Do not use existing cables if they are not in compliance with the sizes detailed in this manual. If you have any doubt about your ability to fuse and wire this unit correctly PLEASE refer to www.abyc.com for a list of certified electricians in your area that are qualified to perform this installation to the ABYC standards.

⚠ WARNING AC Installations have the potential to cause serious injury or death, installations should be performed by an ABYC Certified Electrical Technician to insure a safe and trouble free installation.

24 Volt Systems - This manual is written describing 12V installations, for 24V installations always make sure you have a 24V ProNauticP Charger and that your batteries are configured as a 24 volt system. Each bank requires a separate 24V positive connection to the charger.

Grounding

AC GROUNDING INSTRUCTIONS - The Ground (GND) terminal of the AC input connector must be connected to the AC grounding system at the AC ground buss.

DC GROUNDING INSTRUCTIONS - The case grounding stud should be connected to the DC negative grounding buss (same location as the DC negative output cable terminal) with a cable one size smaller than the DC negative output cable.

AC INSTALLATION MATERIALS AND CONNECTIONS

⚠ WARNING ENSURE MAIN BREAKER IS OFF AND SHORE/STATION POWER IS DISCONNECTED!

If the AC Shore power cord is damaged, it must be replaced by a special cord or assembly available from the manufacturer of the vessel or service agent.

Installation

⚠ CAUTION Make sure AC Shore Power is Disconnected from the Boat and there is no presence of AC Power prior to installation. For new installations always connect Batteries as the LAST STEP. If you are replacing an existing battery charger please disconnect the battery charger output cables from the existing charger AND the battery(s). Do not use existing cables if they are not in compliance with the sizes detailed in this manual. If you have any doubt about your ability to fuse and wire this unit correctly PLEASE refer to for a list of certified electricians in your area that are qualified to perform this installation to the ABYC Standards.

1. Permanent Installation and Circuit Protection - This charger is designed for permanent installation, the AC must be permanently wired to the circuit breaker (dedicated or a branch breaker in a panel) in order to avoid serious injury or death. The following table indicates which breaker & conductor size is appropriate for the model installed. Use only UL 1426 "Boat Cable" with a jacket temperature rating of 105°C, this is commonly available at any marine supply store. Do not use solid cable, speaker wire or welding cable.

Note: Common Breaker sizes are 5, 10, 15, 20 amp for example if charger is listed below as 6 Amp at 110 VAC please use a 10 amp breaker.

AC Breaker Sizing	Charger Model	110-120 volt breaker	220-250 volt breaker	AC conductor size
	ProNautic1210P	5 Amp	5 Amp	14 AWG
	ProNautic1215P	10 Amp	5 Amp	14 AWG
	ProNautic1220P	10 Amp	5 Amp	12 AWG
	ProNautic1230P	10 Amp	10 Amp	12 AWG
	ProNautic1240P	15 Amp	10 Amp	10 AWG
	ProNautic1250P**	15 Amp	10 Amp	10 AWG
	ProNautic1260P**	15 Amp	10 Amp	10 AWG
	ProNautic2420P	15 Amp	10 Amp	12 AWG
	ProNautic2430P**	15 Amp	10 Amp	10 AWG

** These units (1250, 1260, 2430,) require the installation of a split ferrite unit included in the package. It is installed on the AC input cable as shown below.

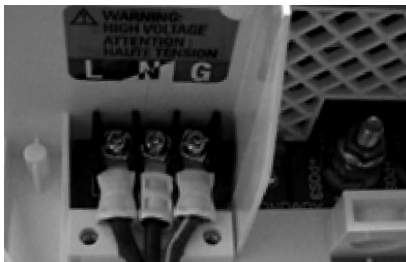

2. Connections – Using ring or captive spade connections and the proper crimping tool, attach the Line – Neutral – Ground to the appropriate terminals on the charger (Note: Label above AC connector is color coded to ensure proper installation). Repeat this procedure for the breaker side of the install. Support cable every 18" and protect from sharp edges and chafing when passing through bulkheads, and other openings all according to ABYC E-11.



3. Split Ferrite - This split ferrite unit is included with models 1250, 1260 and 2430. It must be installed such that all of the AC cabling passes through it as shown. The split ferrite is to be installed immediately before the AC cable enters the charger.

Installation



Please note DC organizer is color coded ensuring proper polarity connections are made.

1. Choosing Conductors – Unlike AC conductors, DC is sensitive to voltage drop, the longer the round trip, the larger the conductor needs to be. Follow the table below for your installation. Like AC, use only UL 1426 "Boat Cable" with a jacket temperature rating of 105°C this is commonly available at any marine supply store. Do not use solid cable, speaker wire or welding cable.

12 Volt 10 Amp	Length of conductor to and from power source				
	10'	15'	20'	25'	30'
Wire length	10'	15'	20'	25'	30'
AWG	14	12	10	10	10
12 Volt 15 Amp					
Wire length	10'	15'	20'	25'	30'
AWG	12	10	10	8	8
12 Volt 20 Amp					
Wire length	10'	15'	20'	25'	30'
AWG	10	10	8	6	6
12 Volt 30 Amp					
Wire length	10'	15'	20'	25'	30'
AWG	10	8	6	6	4
12 Volt 40 Amp					
Wire length	10'	15'	20'	25'	30'
AWG	8	6	6	4	4
12 Volt 50 Amp					
Wire length	10'	15'	20'	25'	30'
AWG	6	6	4	4	2
12 Volt 60 Amp					
Wire length	10'	15'	20'	25'	30'
AWG	6	4	4	2	2
24 Volt 20 Amp					
Wire length	10'	15'	20'	25'	30'
AWG	14	12	10	10	10
24 Volt 30 Amp					
Wire length	10'	15'	20'	25'	30'
AWG	12	10	10	8	8

NOTE: Larger DC cables (generally 4 AWG and larger) require specialty tools to ensure proper termination with ring terminals. DO NOT solder terminals of any size.

Installation

2. Fuse Selection - As illustrated in the diagram, each positive conductor from the charger to the battery/battery bank must be fused. Choose a fuse that is 10 amps higher than the charger output (e.g. 60 amps, choose a fuse of 70 amps). These fuses come in a variety of sizes and types. When choosing the proper fuse consider the connection to the DC cable (inline types for smaller amperages, stud and nut connections for larger amperages) as well as the availability of replacements. Fuses and holders are available through ProMariner or your local marine supply store.

3. Ground - This is extremely important and often overlooked. There is one common battery ground with the positive battery connections on the ProNauticP. There is also a "Chassis Ground".

a. Battery Negative - As shown in the diagram, this is connected to a bus bar or terminal stud (not included) that can handle, at a minimum the amperage of the charger output (1260 = 60 amp minimum). This conductor shall be of equal size to the DC positive conductor chosen above. The battery negative terminals are connected to this bus bar or terminal stud.

b. Bonding Stud A.K.A Chassis Ground - This stud is connected to the boats bonding system as well as the bus bar or terminal stud mentioned above. This conductor is permitted to be one size smaller than the DC positive conductor chosen above; in the case of a DC to the case fault, this conductor is critical in carrying the fault current to trip the fuse or breaker, the AC ground CAN NOT handle high DC amperages.

4. Empty Charger Banks - In the event of an empty charger bank there is no need to use a jumper as done with traditional chargers. Simply leave the DC positive unloaded and the unit will perform correctly.

Remote Temperature Sensor Probe

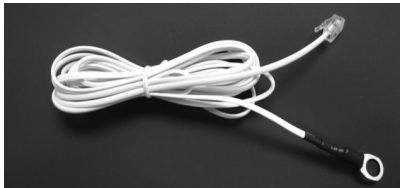

The ProNauticP comes standard with a temperature probe that is plug and play. The temperature probe must be connected while the charger is powered down or before it is connected to the breaker during installation. For best performance, attach the probe to the negative terminal of the "house" batter/bank

Probe Connections:

Battery End (ring terminal) – Connect to the NEGATIVE terminal of the battery.

Charger End – Attach the "phone" style plug into the charger port labeled "BAT SENSE".

Note: Once the temperature sensor is connected the charger will adjust its charge based on the batteries temperature. This is known as thermal compensation, where the charger will cut back if necessary to increase battery life. This is especially useful for AGM and GEL batteries which are inherently temperature sensitive.



Installation

Optional Remote Installation

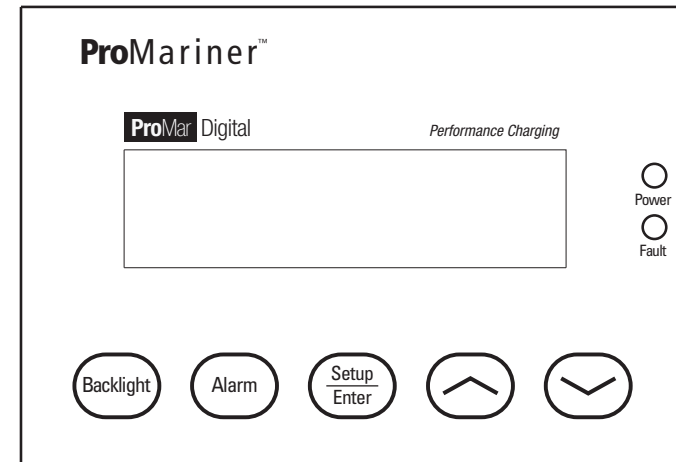

A remote panel is available for your ProNauticP Charger.

The remote is provided with a cable and a network-type plug connector. Pay careful attention to the routing of the cable. Avoid sources of heat and possible chafe when routing.

With the charger powered down, connect the cable to the Helm Remote port on the ProNauticP.

Start-up Guide

Check List

- ✓ Verify AC connections are correct (L,N,G) and secure
- ✓ Verify DC connections (+, -) are correct and secure
- ✓ Verify DC protective cover is installed
- ✓ Connect shore/station power
- ✓ Turn on main AC breaker
- ✓ Turn on charger AC breaker
- ✓ Verify LED's indicators are correct (see operation section)

Please refer to this section to begin using your installed and configured ProNauticP Series charger. This section is not detailed and you should be familiar with the rest of the contents of this manual.

- ✓ Verify shore power/station is connected and main AC breaker is in the ON position.
- ✓ Apply power to your ProNauticP Series charger by switching on branch circuit power. The charger will immediately come on with all LEDs lit while it performs a system check. Once complete the LED display will resume normal operation as it enters the charging mode, DC voltage will increase. LED indicators on the charger are as follows:

Setup and Operation

LED Status Indicator Center		
Feature	LED Color	Function
AC power	blue	indicates power is applied
Auto temp control	green	with remote temp sensor connected
Active PFC	green	pfc active (see features section)
Volts	display system voltage	equal to the charge in the selected profile
Amps	display output amperage	based on state of charge
Charger output	percentage of charge	based on state of charge
Self test	blue	if self test was initiated
OK	green	following successful self test
Ready	green	based on state of charge
Charge	green	based on state of charge
Conditioning	green	based on state of charge

- ✓ Once the batteries have reached programmed voltage, the ProNauticP will automatically switch to conditioning mode, then to ready mode once programmed voltage/time is met, these states will be indicated by the LED's on the charger or the optional remote.
- ✓ The Remote (if equipped) will display real-time voltage/amperage and state-of-charge information, detailed programming and display information can be found in the operation section.
- ✓ The ProNauticP requires no further attention. Once properly installed and programmed the ProNauticP is designed for years of trouble free use with minimal attention. For periodic checks, see the maintenance section.

Note: In the event you change the battery chemistry please refer to the setup and operation section of this manual to reconfigure your charger.

Setup

****Factory Default charging profile is Sealed 2 (14.6VDC Conditioning, 13.4 VDC Float)*

BATTERY TYPES - A word on battery types and the ProMariner ProNauticP. As noted in the Battery Selection Table in the FEATURES section of this manual, this unit can handle 7 different types of commonly available batteries. Batteries are a consumable component and will, at some point, require replacement. Different batteries are charged with dramatically different charging profiles. A change in battery type upon replacement will require resetting of the battery type on the ProNauticP Charger. Identifying the battery type (available on the battery or by contacting the battery manufacturer) and setting the ProNauticP Charger accordingly is a crucial step in ensuring your batteries longevity. ProMariner has pre-programmed the available settings for optimum care of whatever type of battery you find suits your application.

DO NOT GUESS! If you are unsure of your battery type, contact the manufacturer of the battery. Damage caused by an incorrect setting is not covered under warranty.

POWER FACTOR CORRECTION – GLOBAL AC INPUT

Designed to work with an automatic wide range AC input voltage of 100 to 250 VAC and 50-60 Hz allowing all models to operate off of a standard household power connection.

CHARGING RATES – The ProNauticP Charger provides multi stage charging (Charging, Conditioning and Ready) as indicated in the features section.

Setup and Operation

FLOAT MODE OPERATION - When charger is in Float Mode for more then 72 hours and providing less then 5 amps output the unit will go into standby. If amperage is increased above 6 amps for more then 2 minutes charger will come out of standby. When charger is in Float Mode or Standby Mode for 21 days, charger will initiate battery Health Mode and fully recharge batteries ensuring they are ready to go.

RECONDITON/EQUALIZATION – This feature is only recommended for traditional capped and vented lead acid type batteries, and will only operate when those types of batteries are selected, and the user initiates the feature. This process uses high voltage over a short period of time to remove sulphates from the batteries plates. The process “equalizes” the flooded cells and mixes the electrolyte, significantly extending your battery life. Please ensure before you begin this process that the batteries are topped off with distilled water. This function is recommended no more than 4 times per year.

Note: It is recommended to disconnect all 12VDC electronics and monitor the batteries while equalizing as this increases battery gassing and increase the temperature of the battery.

POWER LEVEL ADJUSTMENT – Adjusting the level of available power used by the charger allows other equipment on board to continue to run when you encounter a low power situation such as a 50 amp panel connected to a 30 amp shore/station power connection.

! STOP

BEFORE USING YOUR PRONAUTICP CHARGER READ AND FOLLOW THE BELOW CHECKLIST:

NOTE: Install by referring to the Installation section of this manual OR, as recommended by ProMariner, have your ProNauticP Charger installed by a certified ABYC electrical technician

Begin with the ProNauticP Charger circuit breaker and main shore/station power breaker in the OFF position.

Ensure that all over current protection (e.g. fuses and/or circuit breakers) are ready for use, not blown or tripped.

Verify all connections are tight, corrosion free and of good integrity.

With AC power applied (ProNauticP Charger breaker and shore/station power main ON), observe the following on the Status Indicator Center:

LED Status Indicator Center		
Feature	LED Color	Function
AC power	blue	
Auto temp control	green	with remote temp sensor connected
Active PFC	green	
Volts	display system voltage	equal to the charge in the selected profile
Amps	display output amperage	based on state of charge
Charger output	percentage of charge	based on state of charge
Self test	blue	if self test was initiated
OK	green	following successful self test
Ready	green	based on state of charge
Charge	green	based on state of charge
Conditioning	green	based on state of charge

Setup and Operation

NOTE: This LED configuration indicates that the charger is functioning normally and does not need any further attention. If the RED "Fault" LED illuminates, or any of the "Charger Conditions" LEDs are illuminated, consult the Troubleshooting section of this manual.

OPERATIONAL NOTE: Your ProNauticP Charger has built in safety features that can cause the unit to shut down if it senses out of parameter operations such as over-voltage and high temperatures. See the Troubleshooting section of this manual for more details in the event this occurs.

Optional Remote Display

Optional Remote

Power LED	blue	indicates power is ON
Fault LED	red	indicates a fault
Backlight button	toggle between ON and OFF by pushing repeatedly, default is ON	
Alarm Button	toggle between silent and audible by pushing repeatedly, default is audible	
Setup	selects both "scrolling mode" and activates chosen feature	
Enter	(see optional remote programming section)	
^ v	controls for scrolling in "scroll mode"	

When the optional remote is installed, it will display the current status of the charger along with the voltage and amperage.

1. The blue LED is illuminated when the power is ON
2. BACKLIGHT can be set to ON or OFF by toggling the BACKLIGHT button, default is ON
3. ALARM can be silenced or audible by toggling the ALARM button, default is audible

Setup and Operation

The ProNauticP is a fully automatic battery charger. The features listed below can be selected during initial set-up (see Programming section) or upon a new battery installation. Normal operation does not require any intervention from the user. See the Maintenance section for information on periodic checks.

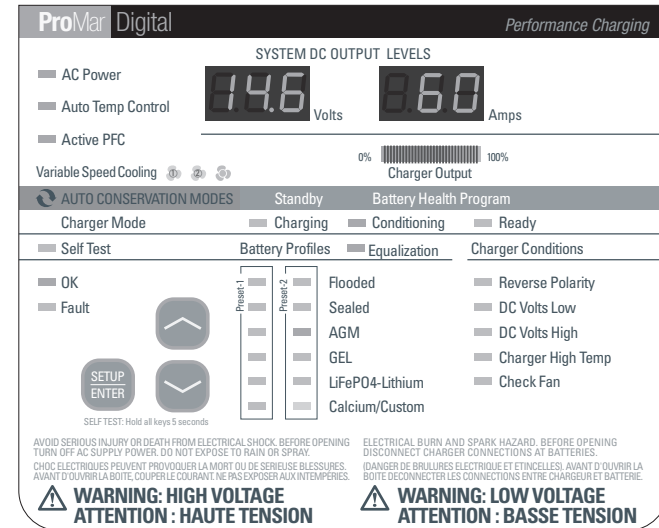

On-Unit LED Indicators and Digital Displays

Feature	Color	Function
AC power	Blue	AC power applied
Auto temp control	Green	Temperature control feature (cooling fan) active, red flashing if high-temp causes unit shutdown (see troubleshooting)
Active PFC	Green	ON when AC power light is on, indicating power factor correction is functioning
Variable speed cooling (1,2,3)	Amber	Indicates speed of fan during auto temp control (feature standard on 20amp and above units).
Charger Mode		
Charge	Green	Charger is in charge mode, actively charging the battery(s) (bulk charge)
Conditioning	Green	The unit is in absorption charge mode
Ready	Green	The charger is in float charge mode
Equalization	Red	Equalization charge has been initiated by user (flooded batteries ONLY, see setup)
Self test	Blue	Charger is performing a system check initiated by start-up or manually
OK	Green	Indicates successful self test
Fault	Red	Indicates a fault (see troubleshooting)

Setup and Operation

Charger Service Conditions		
DC output service (reverse polarity)	Red	Indicates a reverse polarity situation (see troubleshooting)
DC volts low	Amber	DC system voltage is less than 11.0 VDC
DC volts high	Red	Indicates a high DC voltage from an outside source such as a failed alternator/regulator
Charger High Temp	Amber	Charger has shutdown due to high temperature
Check fan	Red	Fan failure
Auto Conservation Mode - Flooded or Sealed Batteries Only		
Standby	Amber	Auto conservation mode enables, when no change in battery charge over 72 hours
Battery Health Program	Amber	After 21 days of standby/float the charger simulates a start-up charge mode
Digital Displays		
Volts/amps	Displays actual voltage/amperage used by the unit	
Charger output	Displays the actual vs available charge rate by percentage	

Battery Types

User Selectable Battery Types				
Battery Types	Preset 1 Profiles		Preset 2 Profiles	
	Charging DC voltage	Float DC Voltage	Charging DC voltage	Float DC Voltage
Flooded	14.8 VDC	13.6 VDC	14.7 VDC	13.4 VDC
Sealed	14.4 VDC	13.6 VDC	14.6 VDC	13.4 VDC
AGM	14.4 VDC	13.4 VDC	14.6 VDC	13.7 VDC
GEL	14.0 VDC	13.7 VDC	14.4 VDC	13.8 VDC
LiFePO4 - Lithium	14.8 VDC	14.4 VDC	14.6 VDC	14.4 VDC
Calcium/Custom			Programmable VDC* default	Programmable VDC* default
	15.1 VDC	13.6 VDC	13.6 VDC	13.6 VDC
Equalization	15.5 VDC	15.5 VDC	15.5 VDC	15.5 VDC

*Damage can result from improper use of the custom setting. Any damage experienced while using this setting is the responsibility of the user and not covered by the Professional Mariner warranty. ALWAYS consult the battery manufacturer if you are unsure of the battery chemistry or appropriate selection.



*For 24 volt models double the voltages shown above or refer to product label.

Lithium Battery Caution: There are many types of Lithium batteries with various charging requirements. Improper charging can result in damage to the battery or catastrophic failure of the battery resulting in battery damage or even fire in extreme cases. You should take extreme caution in the selection of your Lithium Battery system and the all of the onboard charging methods used for this type of battery. The ProNauticP series only provides the bulk and float charging voltage and current for this type of battery. The ProNauticP does not replace the required individual cell management electronics required by lithium batteries. Consult your lithium battery supplier for details.

Programming





SELECTING BATTERY TYPE

To select a battery type/charging profile perform the following:

1. Press and hold the "Setup/Enter" button for 5 seconds.
2. The current battery type and Voltage/Amperage displays will flash.
3. Use the  and  keys to select desired battery type.
4. The Volts and Amps readout will display the charge/conditioning and ready voltages for each profile highlighted.
5. Press the "Setup/Enter" button to confirm selection, the LED will remain solid.



ADJUSTING THE CUSTOM BATTERY TYPE SELECTION

*NOTE: *Damage can result from improper use of the custom setting. Any damage experienced while using this setting is the responsibility of the user and not covered by the Professional Mariner warranty. ALWAYS consult the battery manufacturer if you are unsure of the battery chemistry.*

1. Follow above steps and select the "Custom" option
2. The Volts and Amps will display 13.6 (default at 13.6V)
3. The "Charge/Conditioning" LED will be blinking, indicating it can be changed
4. Use the  and  to select voltage up to 15.1.
5. Press the "Setup/Enter" button to confirm selection, the "Charge/Conditioning" LED should be solid, the "Ready" LED should now be flashing
6. Use the  and  to select voltage up to 15.1.
7. Press the "Setup/Enter" button to confirm selection, the LED will remain solid





NOTE: During this process, real-time voltage and amperages will not be displayed.

SELF TEST MODE



1. Press and hold the "Setup/Enter" and the  and  buttons simultaneously for 5 seconds.
2. Only the "Self Test" LED will flash until the test is complete.
3. OK or Fault LED's will be displayed, see the Troubleshooting section if the Fault LED is illuminated.

EQUALIZATION

NOTE: This function is only recommended for flooded lead acid batteries and will only activate when this type of battery is selected.

1. Use the  and  to select the Equalization LED.
2. Once selected press the  and  for 3 seconds.
3. The LED will remain solid, putting the unit in the equalization setting for 240 minutes.
4. Once complete, the charger will revert back to the previous setting.

POWER LEVEL ADJUSTMENT

1. Hold the  and  buttons simultaneously for 15 seconds
2. Volts will display "PL" for Power Level
3. Press the  to adjust the amperage display from 100, 75, 50, 25% output.



Programming

- Press the "Setup/Enter" button to confirm selection.



NOTE: If no action is taken after 15 seconds, the unit reverts to 100% power.





FACTORY RESET

To return the unit to original factory settings (Sealed 2)

- Follow steps 1 and 2 in the Selecting Battery Type section
- Use the  and  keys until no battery type or equalization LED's are illuminated.
- The Voltage and Amperage displays will show "FAC" "DEF" for factory default.
- Press the "Setup/Enter" button to confirm selection, the charger will re-boot.

PROGRAMMING USING THE OPTIONAL REMOTE

- Pressing SETUP/ENTER displays "SCROLLING"
- Using the  and  (directional) keys scroll through the below menu items,
- Pressing SETUP/ENTER will activate each mode,
- Using the directional keys again will display additional options to be selected, press SETUP/ENTER when done

Remote Panel "Scrolling" Menu Options	
1. Charger Name	Displays charger model
2. Charger Status	Displays Charging/Conditioning/Ready
3. Battery Type Selection	Scroll through available types,
4. Time to Absorption	Displays time left in Absorption mode.
5. Run time	Displays units total run-time
6. Power Level	Displays current power level, allows selection.
7. Battery Temperature	Displays battery temperature
8. Charger Temperature	Displays charger temperature
9. Transformer Temperature	Displays transformer (AC side) temperature
10. Faults	Displays "No Faults Detected" OR allows scrolling through faults, if present, once SETUP/ENTER is pressed, see the Troubleshooting section.
11. Company Information	Displays Professional Mariner information
12. Total Run Time	Displays log of total run time
13. Software revision	Displays the current software version
Remote Shortcuts	
	Press and hold for 10 seconds to force into Ready mode
	Press and hold for 15 seconds for direct access to power level mode
	Press and hold for 5 seconds to initiate Self Test
	Press and hold for 3 seconds, restores Factory Default

NOTES:

*All remote modes/functions are identical to those described by using the on-charger controls.

*10 seconds of inactivity will cause the remote to revert to the previous setting.

Troubleshooting

The ProNauticP includes advanced fault indication. Faults, if indicated, may require service from ProMariner. For inquiries and service information Please call our Customer Care Department line at 1-800-824-0524 from 8:30 am to 5 pm (Eastern Standard Time) for any warranty, service or installation assistance you may need. Thank You

! THERE ARE NO USER SERVICEABLE PARTS INSIDE THE PRONAUTICP. DO NOT ATTEMPT TO DISSASSEMBLE THE UNIT. EVIDENCE OF DISSASSEMBLY WILL VOID MANUFACTURERS WARRANTY.

The first step to any problem is resetting the ProNauticP unit by turning off the AC breaker providing power, waiting at least 10 seconds and turning it back on again.

Review the Operations section for the meaning of the fault indicator and suggestions on how to clear the fault.

Charger Fault (Service) Conditions

LED Label	LED Color	Fault
Reverse Polarity	Red	Indicates a reverse polarity situation
Check DC Connections, ensure positive + (RED) and negative - (BLACK and/or YELLOW) connections are attached accordingly		
DC Volts Low	Amber	DC system voltage is less than 11.0 VDC
Bring system voltage over 11.0 VDC, check battery(s) condition and replace as necessary.		
DC Volts High	Red	Indicates a high DC voltage from an outside source such as a failed alternator
Using a multi-meter check alternator(s) output, generally over 15VDC. Determine if fault exists in regulator or alternator, solar panel, wind generator etc. Replace as needed.		
Charger High Temp	Amber	Charger has shut down due to high temperature
Generally this indicates that the unit has been installed in an area with a very high ambient temperature. This unit is designed for use in an engine room, if installed in an engine compartment; ensure that there is proper ventilation in the space for the charger and other temperature sensitive components. If the installation area temperature is 45° C (113° F) or more, move charger or add ventilation to lower ambient temperature. The recommended maximum ambient temperature for installation is 45° C. (113° F)		
Check Fan	Red	Fan failure
Ensure that the cooling fan can move freely and that no debris is blocking the fan movement. Persistent fan problems require service from ProMariner.		
Fault	Red	Indicates a fault
Please contact ProMariner for service options.		
Auto Temp Control	Red flashing	High temp causes unit shutdown
See charger high temp above		

Note: Installation is permitted in an environment of 45° C (113° F) and may result in output of unit decreasing to protect the internal components and the performance of the unit.

Maintenance

This unit is solid state and requires no constant adjustment or constant attention; however, the following items should be checked:

Maintenance Item	Start Up	Monthly
Verify LED status panel shows no fault condition and indicates normal operation.	✓	
Condition of fuses/breakers check for as-new condition on fuses (e.g. no discoloration or corrosion) and that a breaker will manually trip and reset.	✓	
Check for proper ventilation and that no debris has collected on the fan shroud or items have been improperly stored around the ProNauticP.	✓	
Check battery terminal connections (both at battery and the ProNauticP Charger) for corrosion, clean and reconnect immediately upon signs of corrosion.		✓
Per manufacturer's instructions, check and top off batteries with distilled water. Use of tap or bottled drinking water will damage battery plates due to mineral content.		✓
Check wire condition, overheating due to excessively long or too small conductors will result in hardening of the insulation or even burn marks at connections; If any of these signs exist, immediately remedy the situation by installing the proper conductors.		✓

Dimensions

ProNauticP 12volt 10-40 Amp and 24 volt 20 Amp Dimensions Inches (mm)

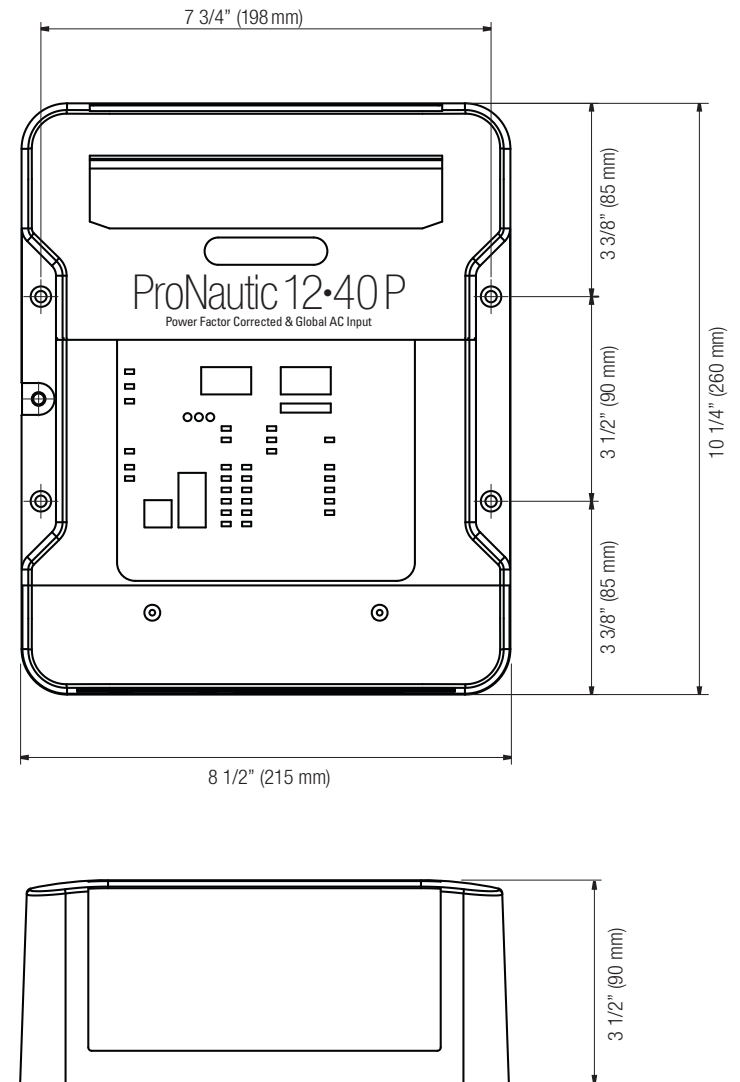

Dimensions

ProNauticP (12 volt) 50-60 Amp and (24 volt) 30 Amp Dimensions Inches (mm)

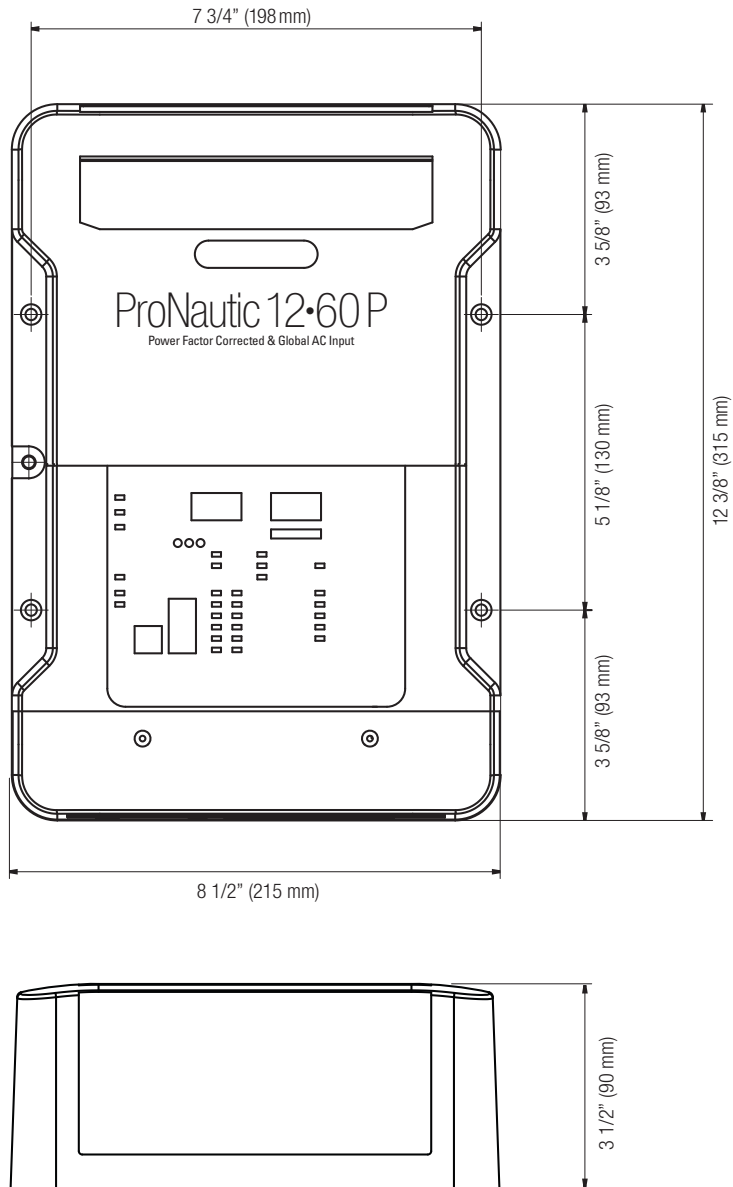

Dimensions

Optional Remote Dimensions Inches (mm)

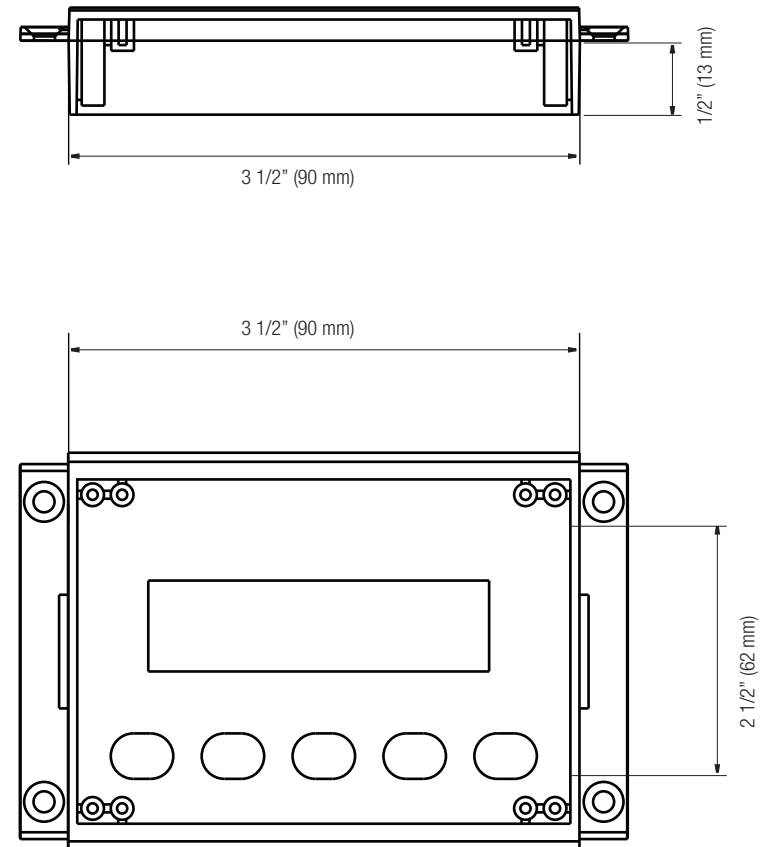

Typical Wiring Configurations

Typical 3 Bank 12 Volt DC Common Ground Installation:

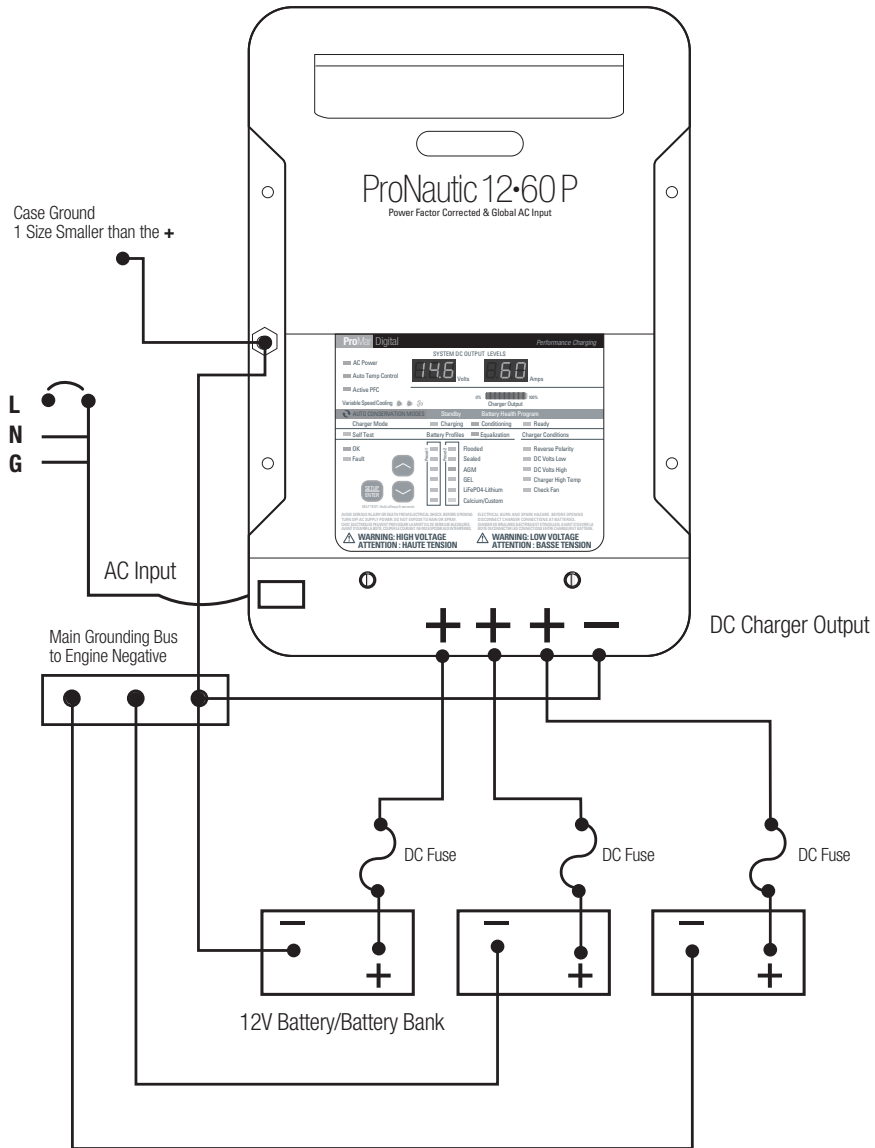

Typical Wiring Configurations

Typical 2 Bank 12 Volt DC Common Ground Installation:

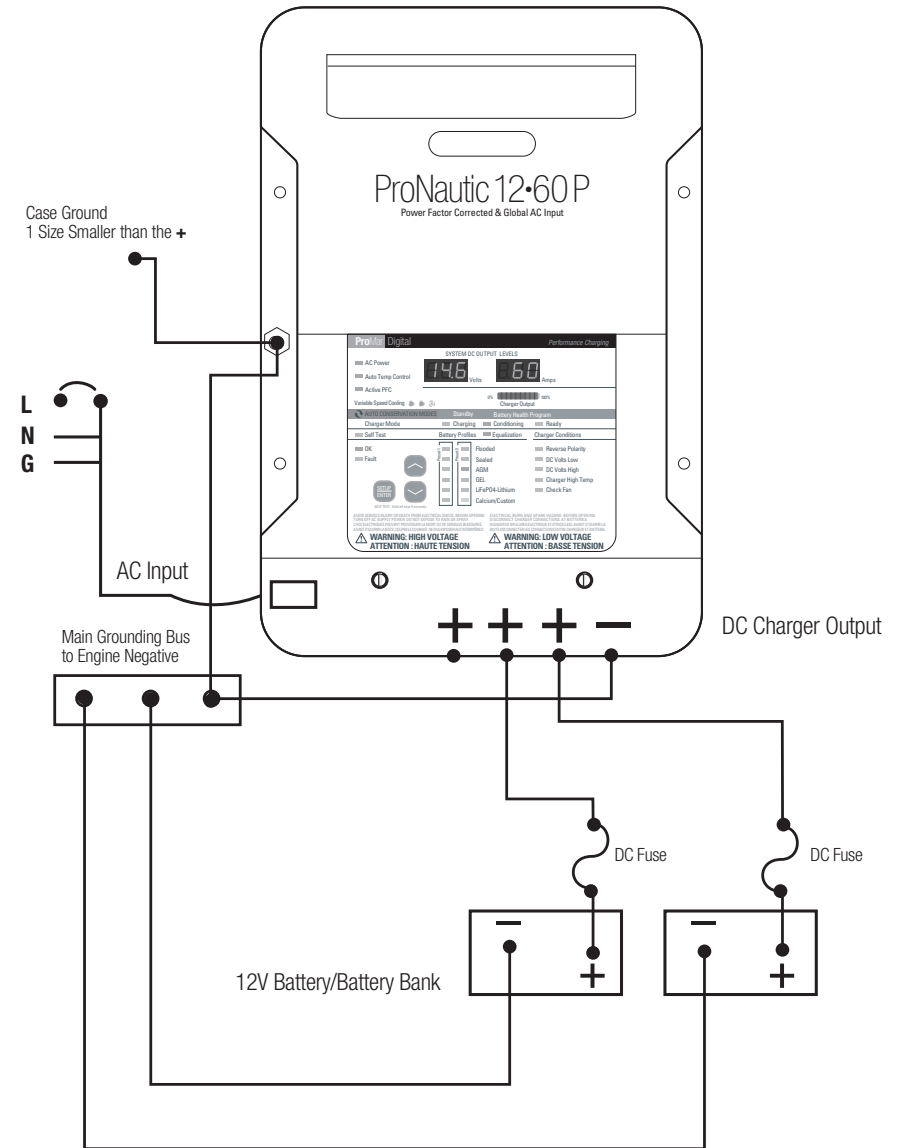

Typical Wiring Configurations

Typical Single 12 Volt DC Common Ground Installation:

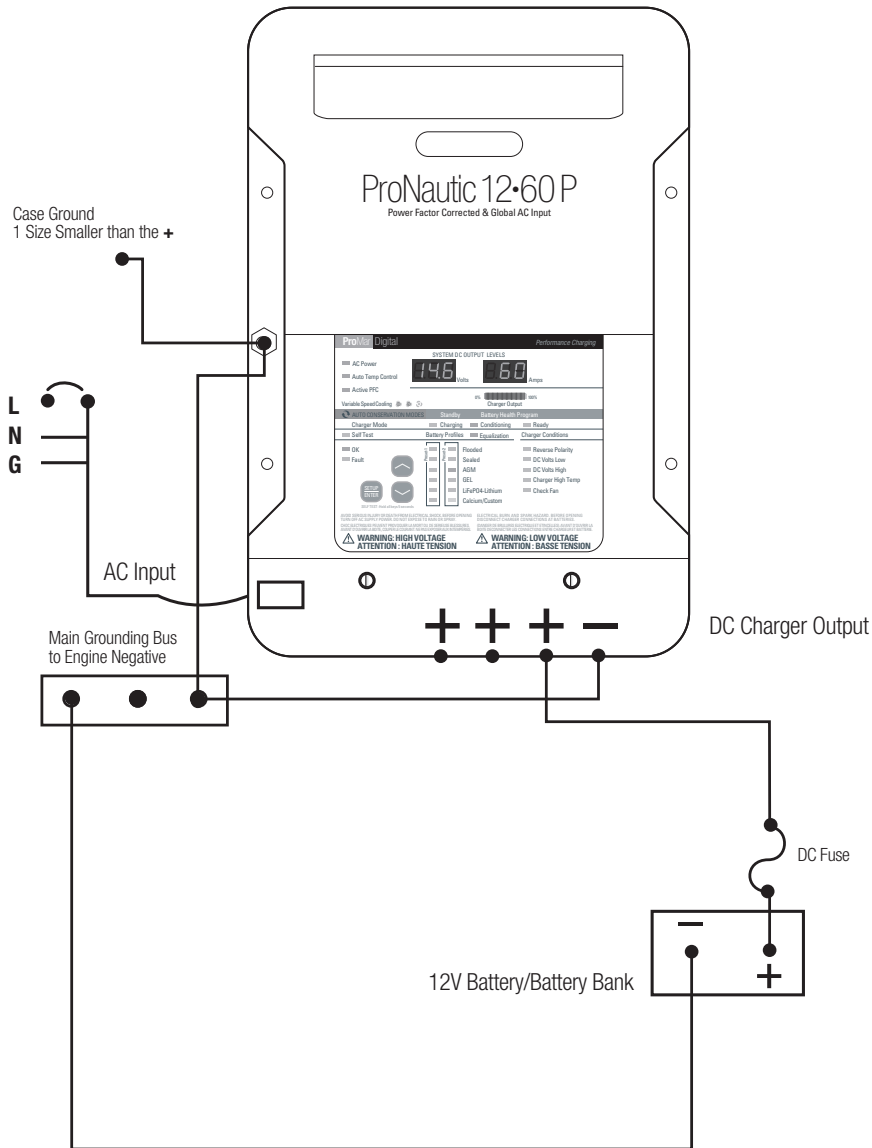

Warranty

WARRANTY CARD CAN BE REGISTERED AT WWW.PROMARINER.COM or the warranty card included in this manual can be completed and sent to ProMariner by mail.

PRONAUTICP SERIES ON-BOARD MARINE BATTERY CHARGER FIVE YEAR WARRANTY

Each ProMariner ProNauticP Series Model is guaranteed against defects in material and workmanship for five full years after purchase. Each serial numbered product has an additional repair adjustment provision after the 5 year limited warranty that limits the maximum charge for repair or replacement to 50% of the current list price, plus shipping and handling.

- Warranty and repair adjustment calculated from manufacture date if not registered or proof of purchase within two weeks of sale.
- Warranty void if unauthorized repairs attempted.
- Water damage not covered under warranty
- Customer is responsible for shipping to ProMariner.
- Cosmetic repairs are done at the owner's request and expense.

Purchase or other acceptance of the product shall be on the condition and agreement that Professional Mariner, LLC SHALL NOT BE LIABLE FOR INCIDENTAL OR CONSEQUENTIAL DAMAGES OF ANY KIND. (Some states do not allow the exclusion or limitation of incidental or consequential damages, so the above limitations may not apply to you.) This warranty is made in lieu of all other obligations or liabilities on the part of Professional Mariner. Professional Mariner neither assumes nor authorizes any person for any obligation or liability in connection with the sale of this product.

To make a claim under warranty, go to www.promariner.com and click on the support tab and follow the instructions making sure to identify the product and the problem. If you can not use our online warranty claim registration, please feel free to call ProMariner at the toll free number listed below. Professional Mariner will make its best effort to repair or replace the product, if found defective within the terms of the warranty, within 30 days after return of the product to the company. Professional Mariner will ship the repaired or replaced product back to the purchaser. This warranty gives you specific legal rights, and you may also have other rights, which vary from state to state. This warranty is in lieu of all others expressed or implied.

Factory Service Center & Technical Support
 Professional Mariner, LLC
 200 International Drive, STE 195
 Portsmouth, NH 03801.
 Tel: 1-800-824-0524

Professional Mariner, LLC
 Tel: (603) 433-4440 / Fax: (603) 433-4442

Notes

Notes
